

---

# *Optimizing Pulping and Oxygen Bleaching to Improve Yield*

*Hasan Jameel, Adrianna Kirkman*

*North Carolina State University*

*Art Ragauskauskas, Lucian Lucia*

*Institute of Paper Science and Technology*

# *Introduction*

---

*Oxygen delignification has become one of the important technologies to decrease the kappa number of the to the bleach plant*

- *Potential for improving yield by optimizing*
  - *Pulping*
  - *Oxygen bleaching*

# *Objective*

---

- *Influence Of Kraft Pulping Conditions on*
  - *Pulping*
  - *Oxygen delignification*
  
- *Effect on Oxygen Delignification*
  - *Effect of Temperature, NaOH*
  - *To be analyzed by response variables*
    - *Kappa*
    - *Yield*
    - *Viscosity*

# *Joint Project*

---

- *NC State University*
  - *Analyze The Influence of Process Parameters on Selectivity*
  
- *IPST*
  - *Chemistry of Extended Oxygen Delignified pulps, impact on physical properties of pulp.*

# *Single Stage Oxygen Delignification*

---

- *Softwood 30 Kappa pulps prepared*
- *Varying pulping conditions*
  - *Low AA 17%AA*
  - *Medium AA 19%AA*
  - *High AA 21%AA*
- *Temperature kept constant at 170°C*
- *Single stage oxygen delignification studied using experimental design*

# *Single Stage Oxygen Experimental Plan*

---

- *% NaOH*
  - *1 - 5%*
- *Temperature*
  - *70-110°C*
- *Carryover: 10%*
- *O<sub>2</sub> pressure: 40 psig*
- *Medium Consistency -10 %*
- *Conditions evaluated using statistically designed experimental plan - 11 experiments*

# *Pulping Conditions*

## *30 Kappa*

---

	<b>%AA</b>	<b>H- Factor</b>	<b>Kappa</b>	<b>Yield %</b>	<b>Viscosity cp</b>
<b>Low</b>	<b>17</b>	<b>2200</b>	<b>30.0</b>	<b>46.0</b>	<b>33.9</b>
<b>Medium</b>	<b>19</b>	<b>1800</b>	<b>30.2</b>	<b>44.4</b>	<b>22.2</b>
<b>High</b>	<b>21</b>	<b>1250</b>	<b>30.1</b>	<b>43.0</b>	<b>20</b>

# *Oxygen Delignification*

## *30 Kappa Pulps 17%AA*

---

Low AA Pulping, 30 K					
NaOH%	Temp	Kappa	Yield	Viscosity	Total Yield
3	70-75	19.9	97.8	23.6	45.0
1.6	76.5-78	20.0	97.0	26.2	44.6
4.4	76.5-78	17.4	95.0	22.6	43.7
1	90-92	20.0	96.0	21.8	44.2
3	90-92	15.6	94.7	18.0	43.6
5	90-92	13.9	93.5	15.1	43.0
1.6	104-105	15.6	94.0	15.9	43.2
4.4	104-105	12.0	94.2	13.3	43.3
3	108-112	12.3	95.0	15.2	43.7
3	88-92	15.5	96.2	20.4	44.3
3	90-92	15.7	95.5	18.6	43.9



# *Models for Low AA*

## *30 Kappa Pulps 17%AA*

---

### ■ *LOW AA PULP:*

- $KAPPA = 15.77 - 2.636 * ((NaOH - 3) / 2) - 3.652 * ((Temp - 90) / 20) + 1.1115 * ((NaOH - 3) / 2)^2$
- $YIELD = 44.06 - 0.4444 * ((NaOH - 3) / 2) - 0.646 * ((Temp - 90) / 20) - 0.5525 * ((NaOH - 3) / 2)^2$
- $VISCOSITY = 19.154 - 2.788 * ((NaOH - 3) / 2) - 5.686 * ((Temp - 90) / 20)$

# *Effect of Temperature*

## *30 Kappa Pulps 17%AA*

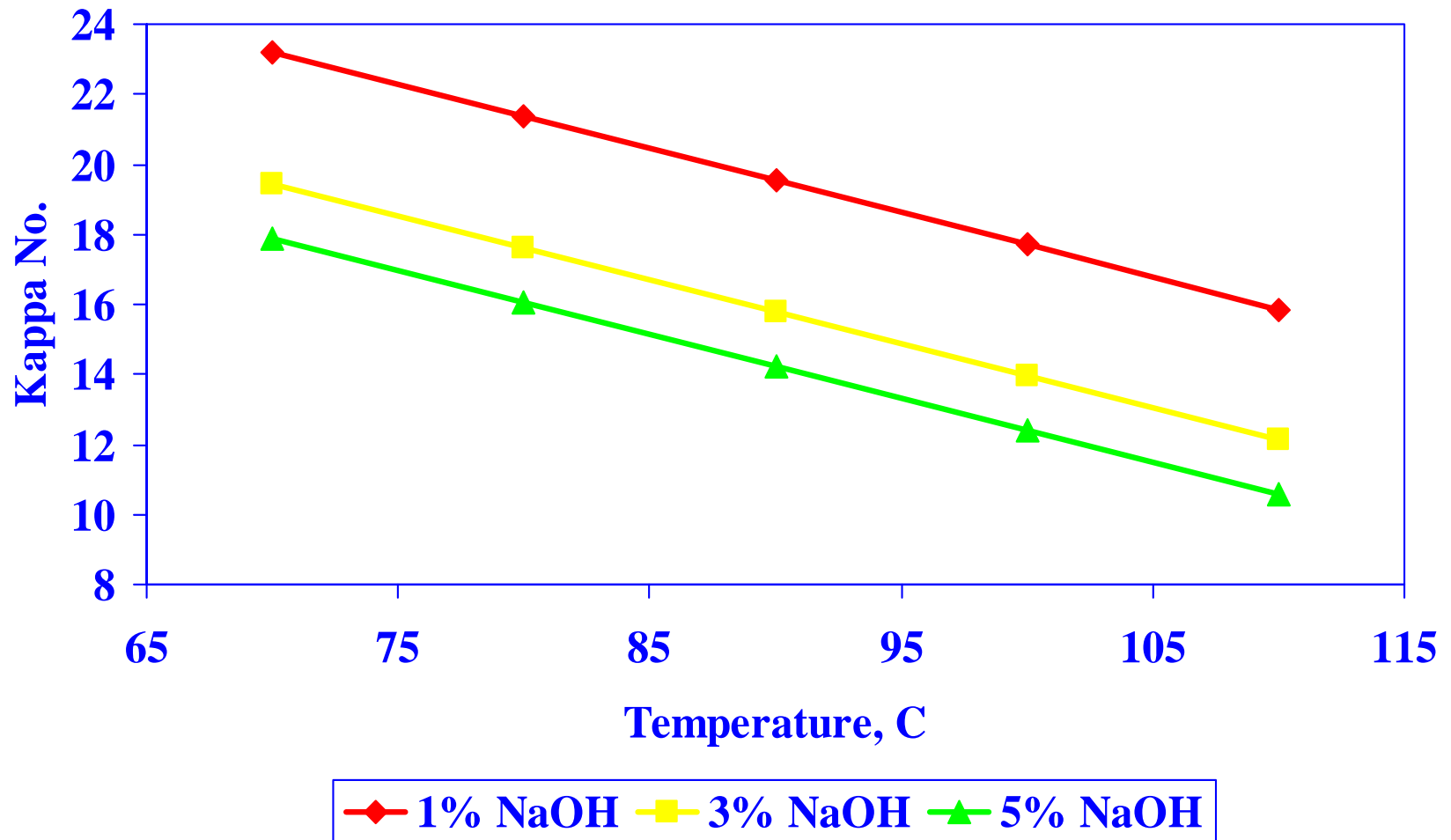

# *Effect of %NaOH*

*30 Kappa Pulps 17%AA*

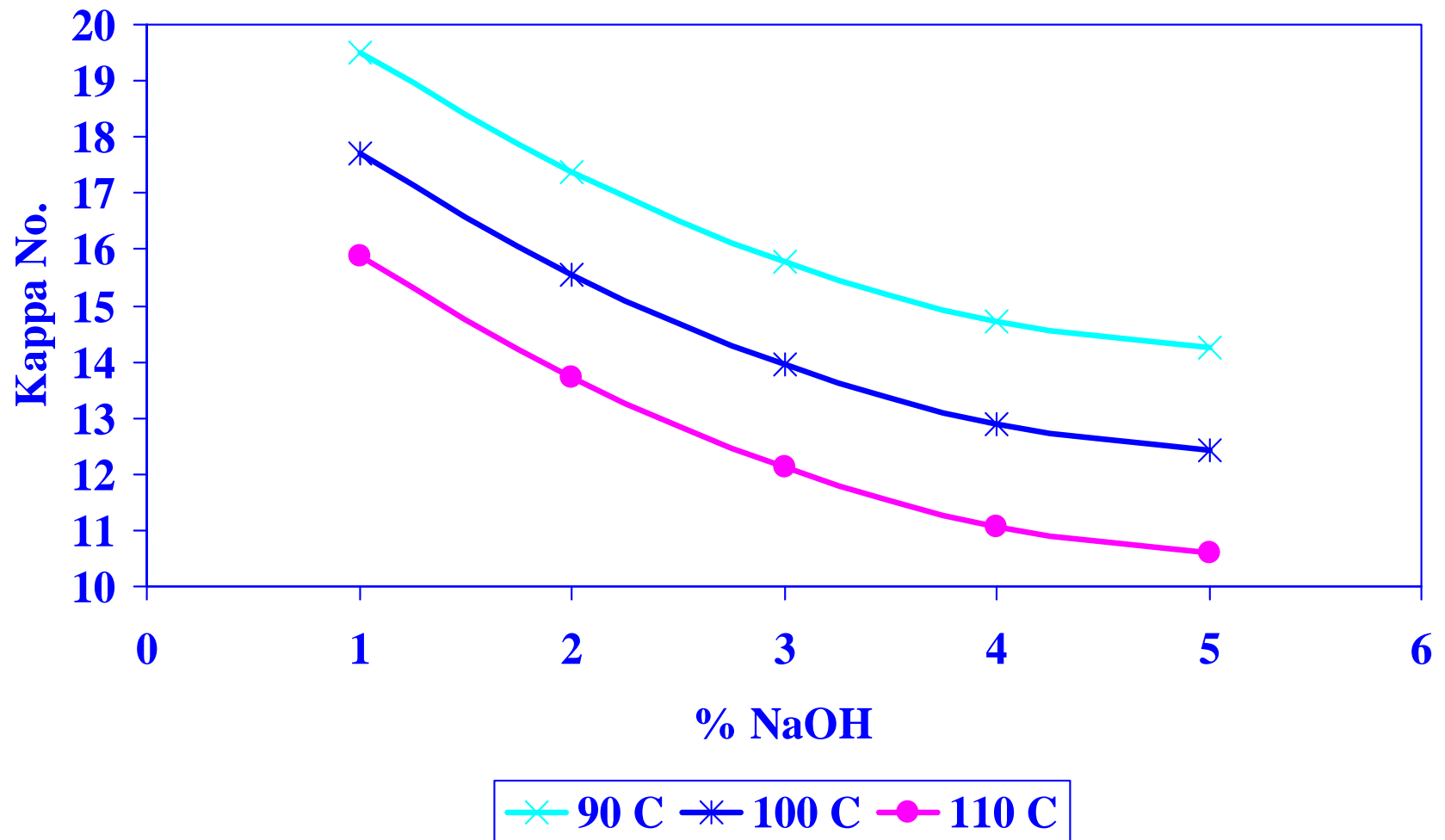

# *Oxygen Delignification*

## *30 Kappa Pulps 19%AA*

---

% NaOH	Temp	Yield	Kappa	Viscosity	Total Yield
3	70.5	98.3	22.3	20.3	45.7
1.6	77.5	99.4	21.0	18.6	46.2
4.4	77.5	98.5	17.3	17.0	45.8
1	93.2	99.2	20.2	19.2	46.1
3	93.2	98.2	15.4	16.9	45.7
5	93.2	98.5	15.9	16.0	45.8
1.6	103.4	98.2	17.7	17.3	45.7
4.4	103.5	95.0	12.4	12.7	44.2
3	109.5	96.0	12.2	13.4	44.6
3	90.5	98.5	16.5	17.2	45.8
3	91	98.7	16.8	17.2	45.9

# *Models for Medium AA*

## *30 Kappa Pulps 19%AA*

---

### ■ *MEDIUM AA PULP:*

- $KAPPA = 15.484 - 2.577 * ((NaOH - 3) / 2) - 4.0 * ((Temp - 90) / 20) + 1.3317 * ((NaOH - 3) / 2)^2$
- $YIELD = 43.25 - 0.41162 * ((NaOH - 3) / 2) - 0.65 * ((Temp - 90) / 20) - 0.561 * ((NaOH - 3) / 2) * ((Temp - 90) / 20) - 0.723 * ((TEMP - 90) / 20)^2$
- $VISCOSITY = 16.89 - 1.904 * ((NaOH - 3) / 2) - 2.732 * ((Temp - 90) / 20)$

# *Oxygen Delignification*

## *30 Kappa Pulps 21%AA*

High AA Pulping, 30 K					
NaOH%	Temp	Kappa	Yield	Viscosity	Total yield
3	70-73	19.0	98.8	18.2	42.5
1.6	76-77	20.0	99.0	19.3	42.6
4.4	76-77	16.7	98.0	16.4	42.1
1	90-91	18.4	99.0	18.9	42.6
3	90-91	16.8	98.5	17.5	42.4
5	89-92	13.4	97.9	12.3	42.1
1.6	102-104	15.3	98.0	15.4	42.1
4.4	102-104	11.0	97.5	8.9	41.9
3	107-109	11.3	97.2	9.7	41.8
3	92-94	15.0	98.0	13.8	42.1
3	90-91	16.6	98.7	17.3	42.4

# *Models for High AA*

## *30 Kappa Pulps 21%AA*

---

### ■ *HIGH AA PULP:*

- $KAPPA = 15.323 - 2.606 * ((NaOH - 3) / 2) - 3.78 * ((Temp - 90) / 20) + 0.137 * ((NaOH - 3) / 2)^2$
- $YIELD = 41.3059 - 2.0 * ((NaOH - 3) / 2) - 0.3005 * ((Temp - 90) / 20) - 0.1909 * ((Temp - 90) / 20)^2$
- $VISCOSITY = 15.245 - 3.328 * ((NaOH - 3) / 2) - 4.162 * ((Temp - 90) / 20)$

# *Influence Of Pulping Conditions*

---

- *Kappa Reduction*
- *Yield Selectivity*
- *Viscosity Selectivity*



# *Kappa vs Temp (1% NaOH)*

*30 Kappa 100 C*

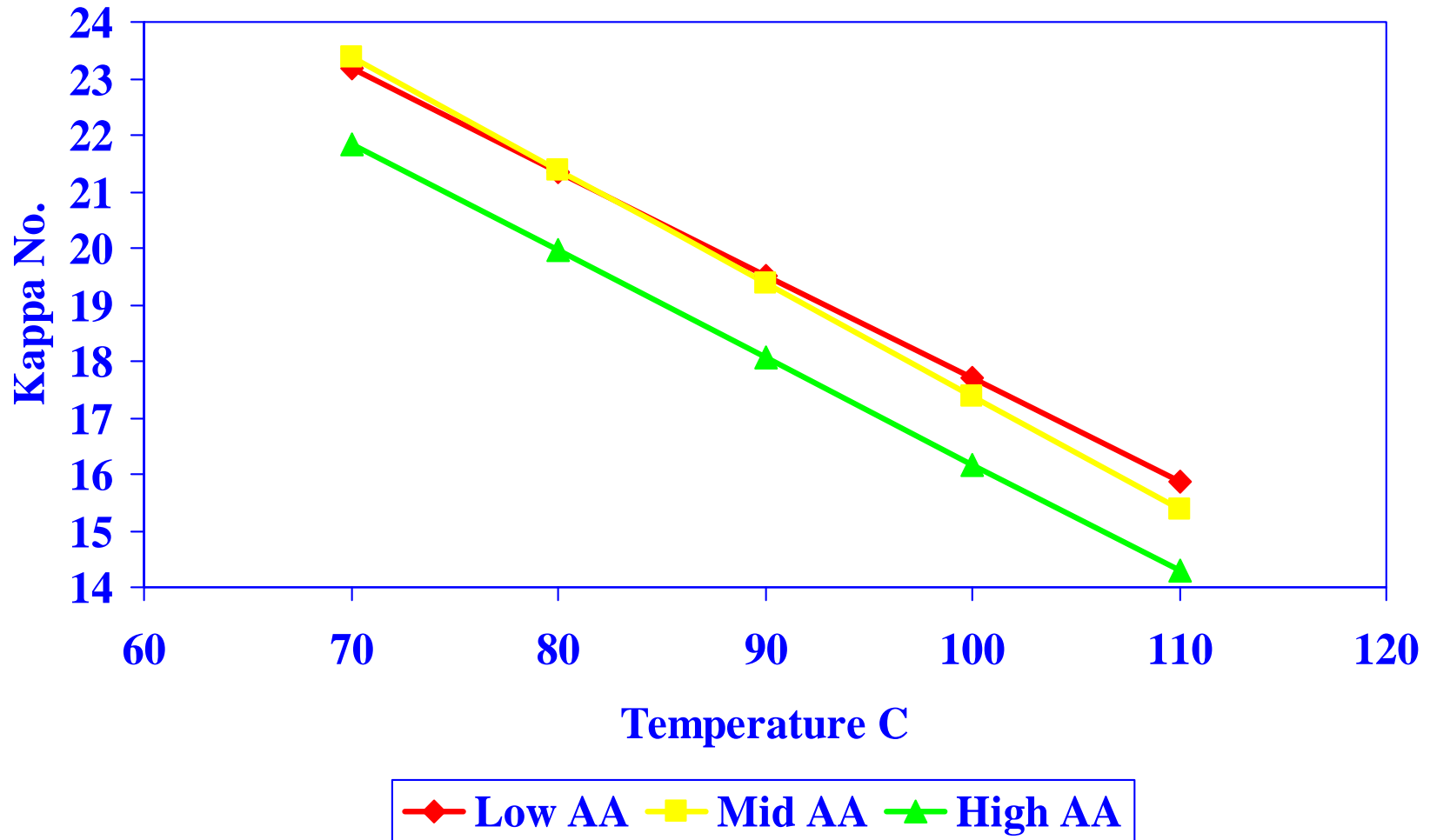

# *Delignification in Oxygen Stage*

## *30 Kappa 100 C*

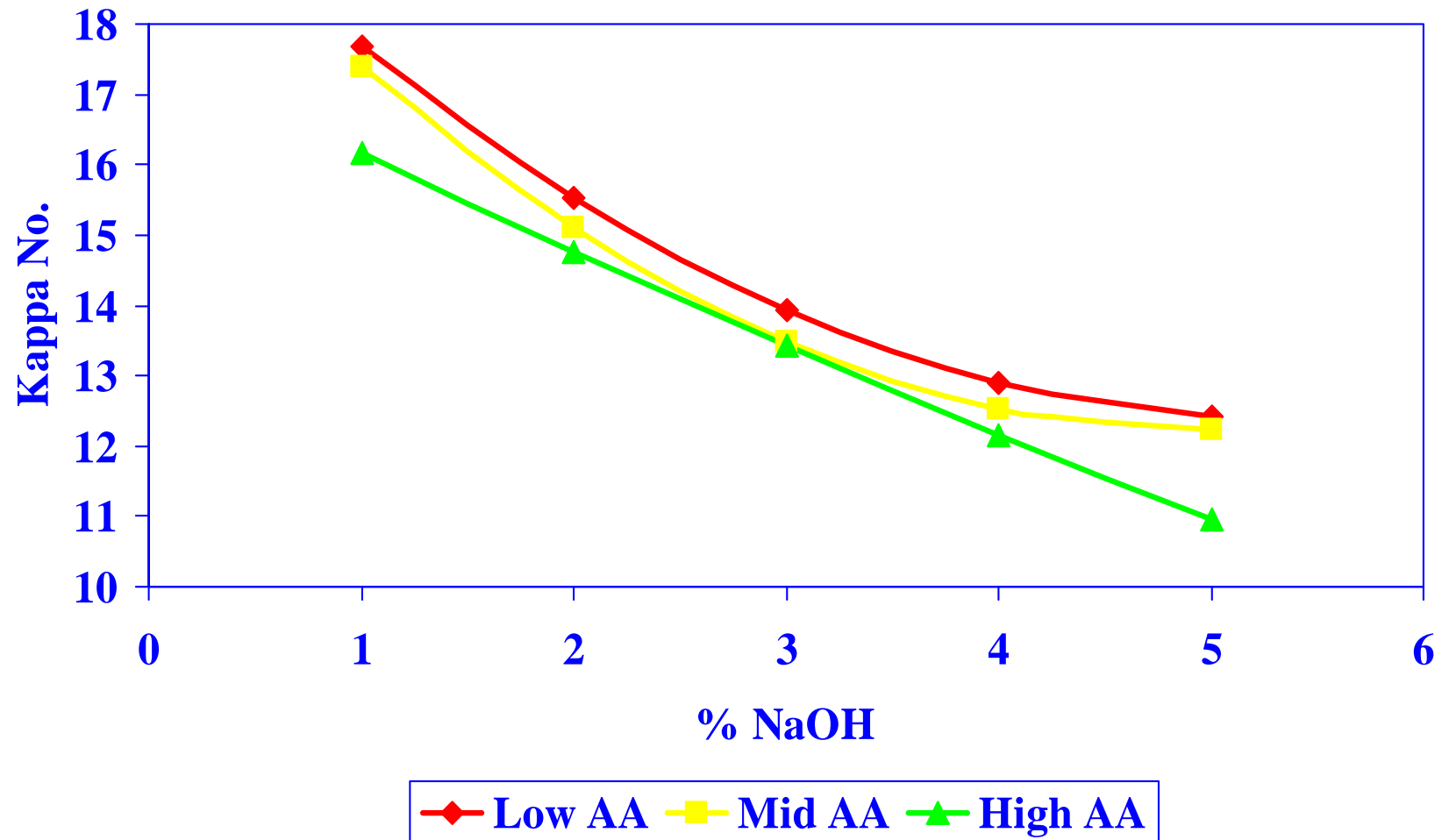

# *Yield vs Kappa Number*

## *30 Kappa 100 C*

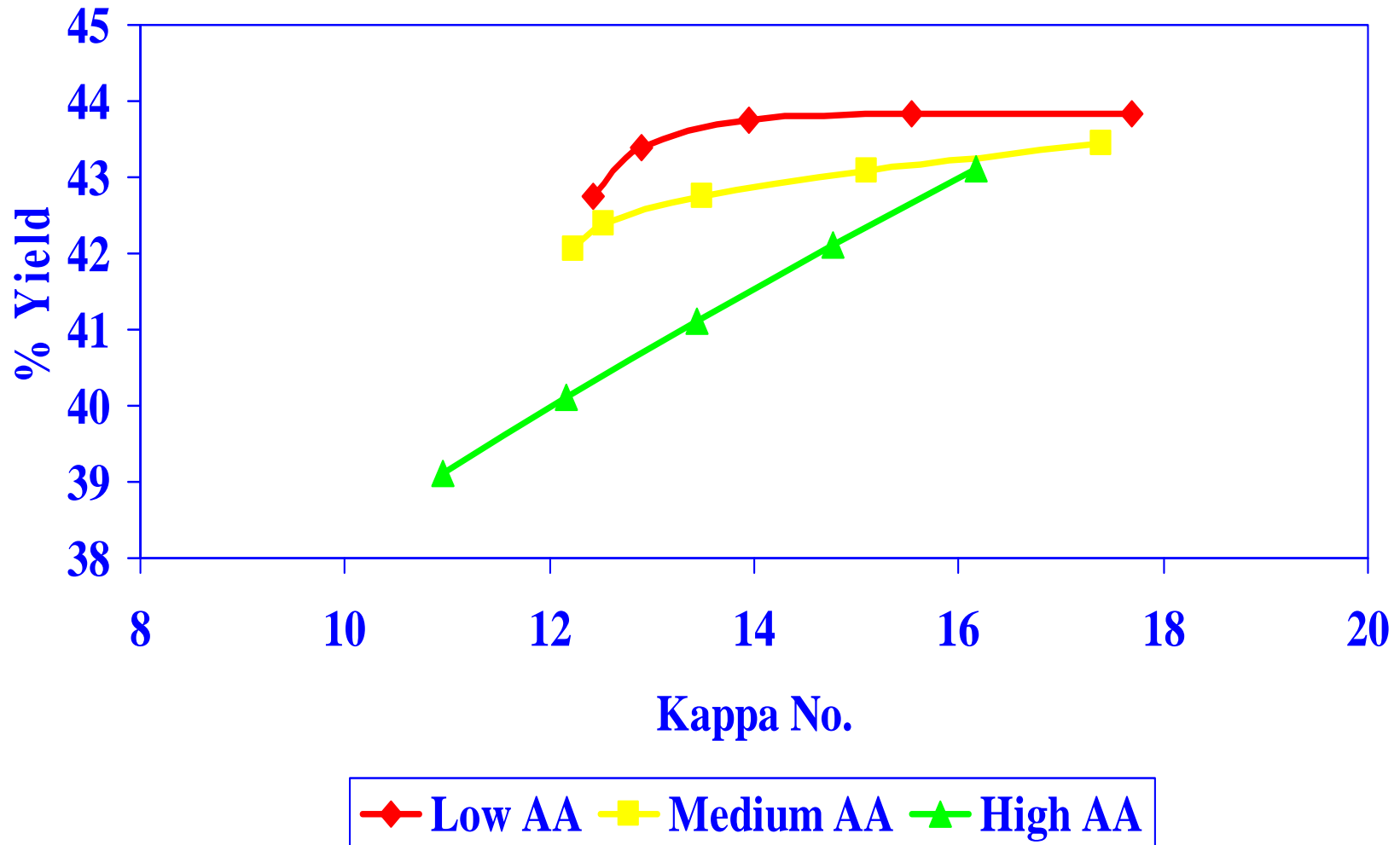

# *Yield vs Kappa*

*30 Kappa 3% NaOH*

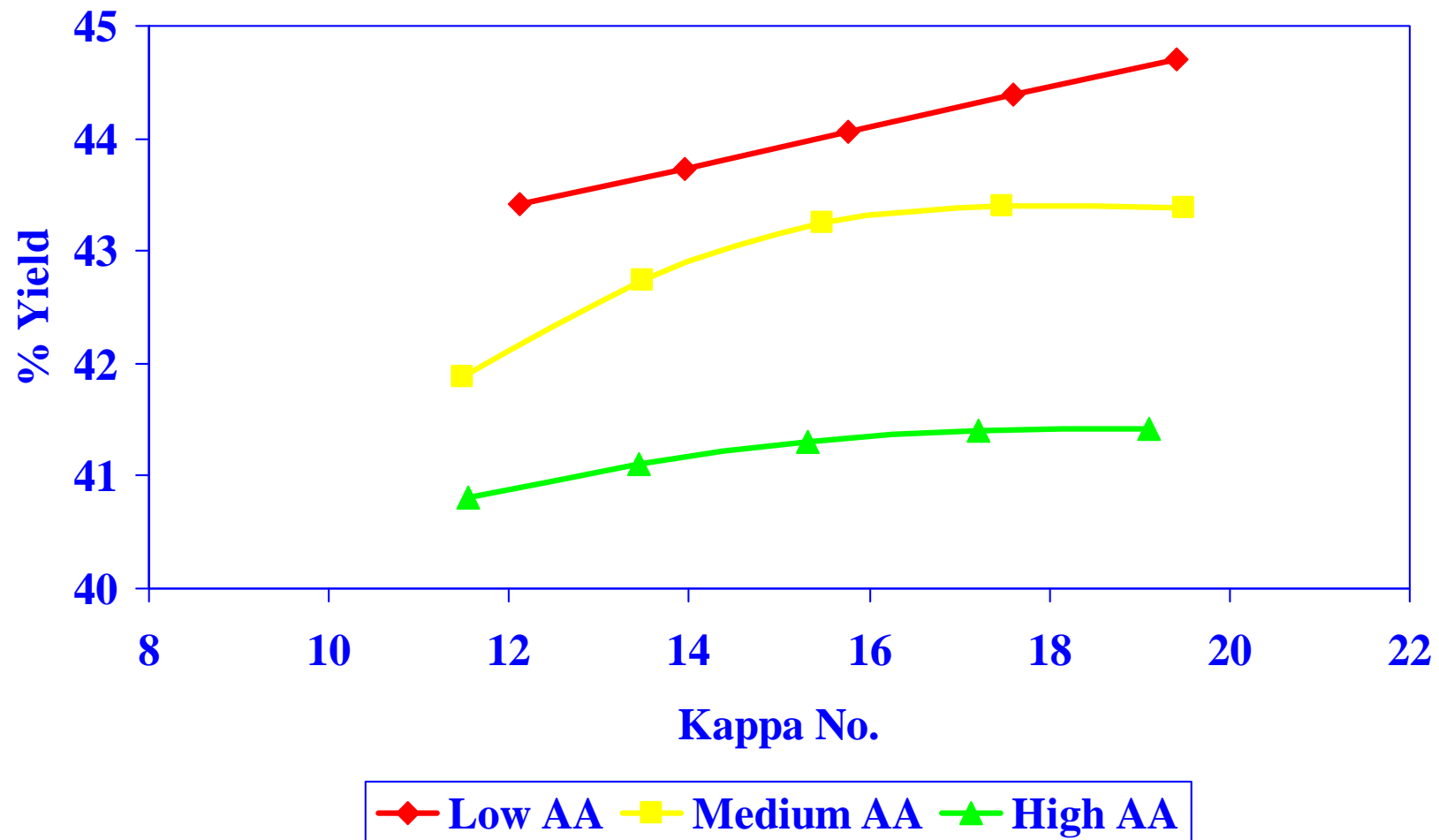

# *Viscosity vs Kappa No.*

## *30 Kappa 3% NaOH*

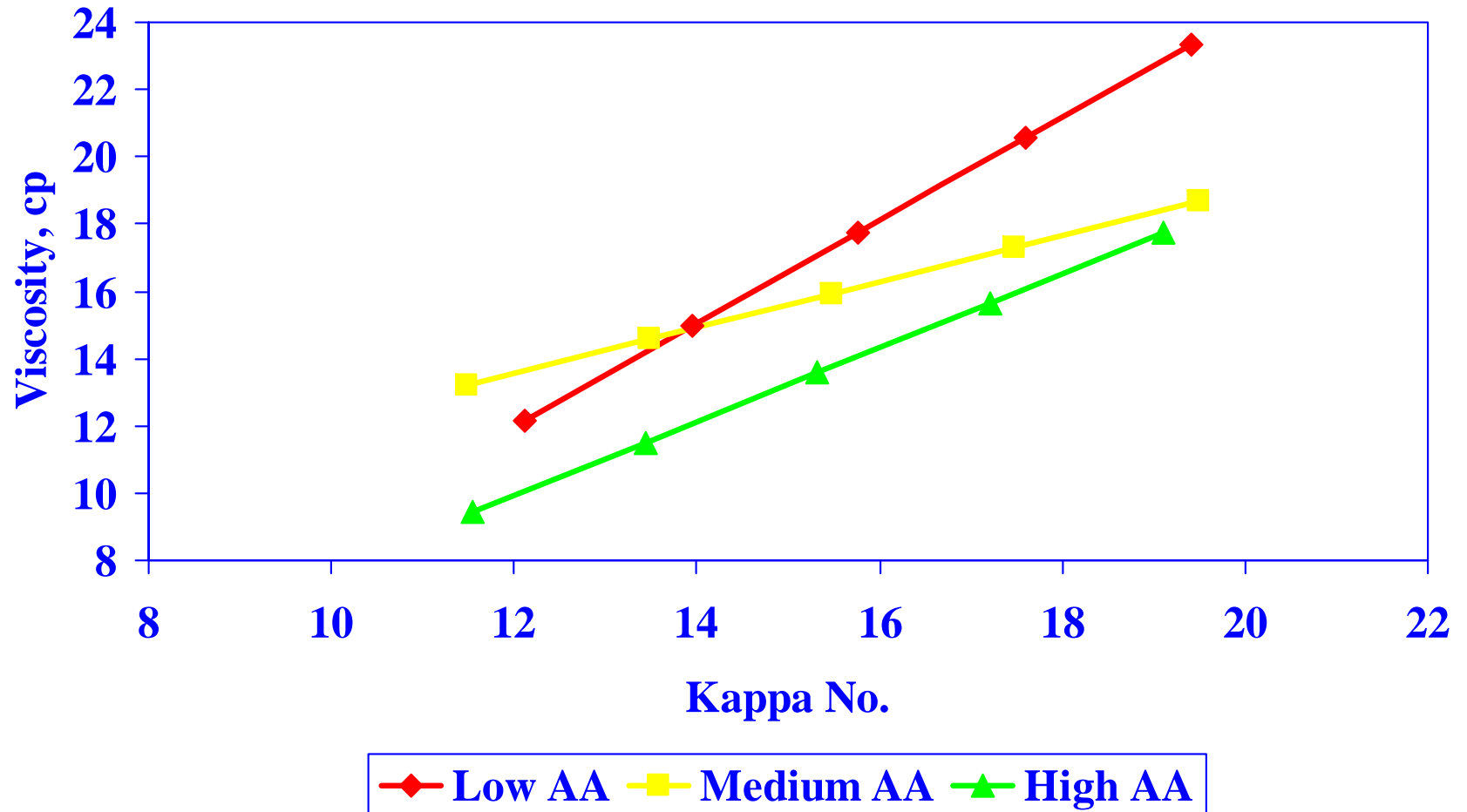

# *Hardwood Pulping Data*

---

<i>AA%</i>	<i>H Factor</i>	<i>Kappa No</i>	<i>Yield. %</i>
<i>14</i>	<i>1000</i>	<i>19.1</i>	<i>53.2</i>
<i>16</i>	<i>650</i>	<i>19.4</i>	<i>47.3</i>
<i>18</i>	<i>500</i>	<i>19.9</i>	<i>47.2</i>

# *Hardwood Oxygen Models*

---

## **LOW AA (14%)**

$$\text{KAPPA} = 14.8 - 1.53 * \text{NAOH} - 2.84 * \text{TEMP} + 0.4 * \text{NAOH}^2$$

$$\text{VISCOSITY} = 40.3 - 4.68 * \text{NAOH} - 4.69 * \text{TEMP}$$

$$\text{YIELD} = 43.8 - 0.35354 * \text{NAOH} - 0.51515 * \text{TEMP}$$

## **MEDIUM AA (16%)**

$$\text{KAPPA} = 14.41 - 1.38 * \text{NAOH} - 2.54 * \text{TEMP} + .97 * \text{NAOH}^2$$

$$\text{YIELD} = 40.54 - .01 * \text{NAOH} - .06 * \text{TEMP} + .124 * \text{TEMP}^2 + .27 * \text{NAOH}^2$$

$$\text{VISCOSITY} = 1.39129 + 0.62753 * \text{NAOH} + 2.32143 * \text{NAOH} * \text{TEMP} - 2.77632 * \text{TEMP}^2$$

# *Hardwood Oxygen Models*

---

## **HIGH AA (18%)**

$$\text{YIELD} = 98.81956 - 0.28535 * \text{NAOH} - 0.19444 * \text{TEMP} + 0.42546 * \text{NAOH}^2$$

$$\text{KAPPA} = 14.2 - 2.0 * \text{NAOH} - 1.98 * \text{TEMP}$$

$$\text{VISCOSITY} = 31.39129 + 0.62753 * \text{NAOH} + 2.32143 * \text{NAOH} * \text{TEMP} - 2.77632 * \text{TEMP}^2$$



# Harwood Delignification

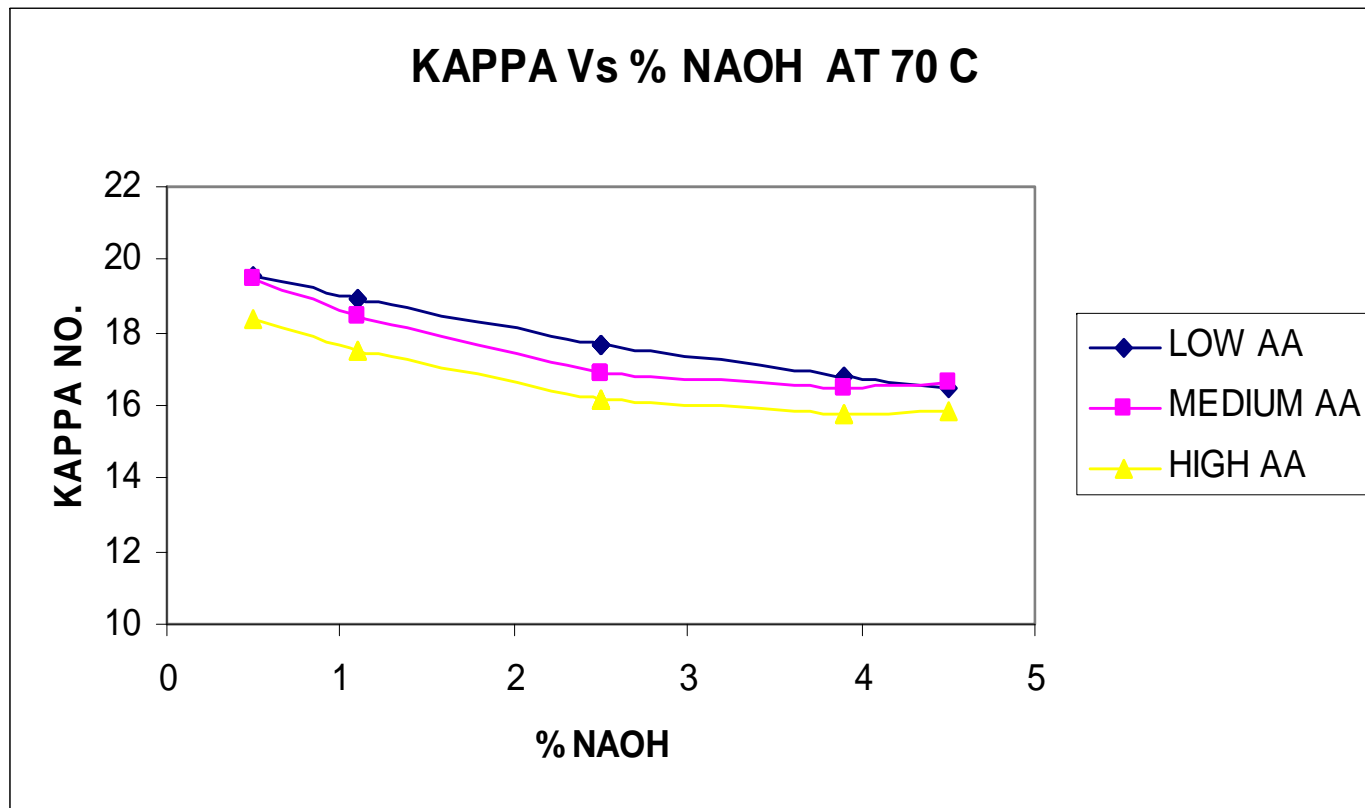

# *Harwood Delignification*

---

# Summary

---

- *The higher alkali charge in pulping resulted in lower yield at the same kappa number*
  - 17%AA            46% yield
  - 21%AA            43% yield
- *The pulps produced with the low AA were slightly more difficult to delignify as compared to the high AA pulps*
- *The yield and viscosity selectivity was higher for the low %AA in pulping*
  - improvements of up to 2% in yield
  - improvements of up to 4cp in viscosity

# *Summary*

---

- *Similar results were observed with hardwood*
  - *Low %AA pulps were slightly more difficult to delignify*
  - *The yield from the low AA pulps were significantly higher especially at 14%AA*

# *Validation of Results- Softwood*

---

	17% AA	21% AA
Pulping		
%AA	17	21
H Factor	2200	1250
Kappa	30	30
Yield, %	46.5	43.5
Viscosity, cp	33.7	27

# *Validation of Results*

---

	<b>17% AA</b>	<b>21% AA</b>
<b>Oxygen Stage</b>		
<b>%NaOH</b>	<b>3.3</b>	<b>3</b>
<b>Temp, C</b>	<b>92</b>	<b>92</b>
<b>Kappa</b>	<b>16</b>	<b>16.5</b>
<b>Oxygen yield, %</b>	<b>97</b>	<b>96.8</b>
<b>Total yield,% (Pulp+O2)</b>	<b>45.1</b>	<b>42.1</b>
<b>Viscosity, cp</b>	<b>24.5</b>	<b>21</b>

---

**High-Kappa Pulping  
and  
Extended Oxygen Delignification  
to Increase Yield**

# *Yield Kappa Relationships*

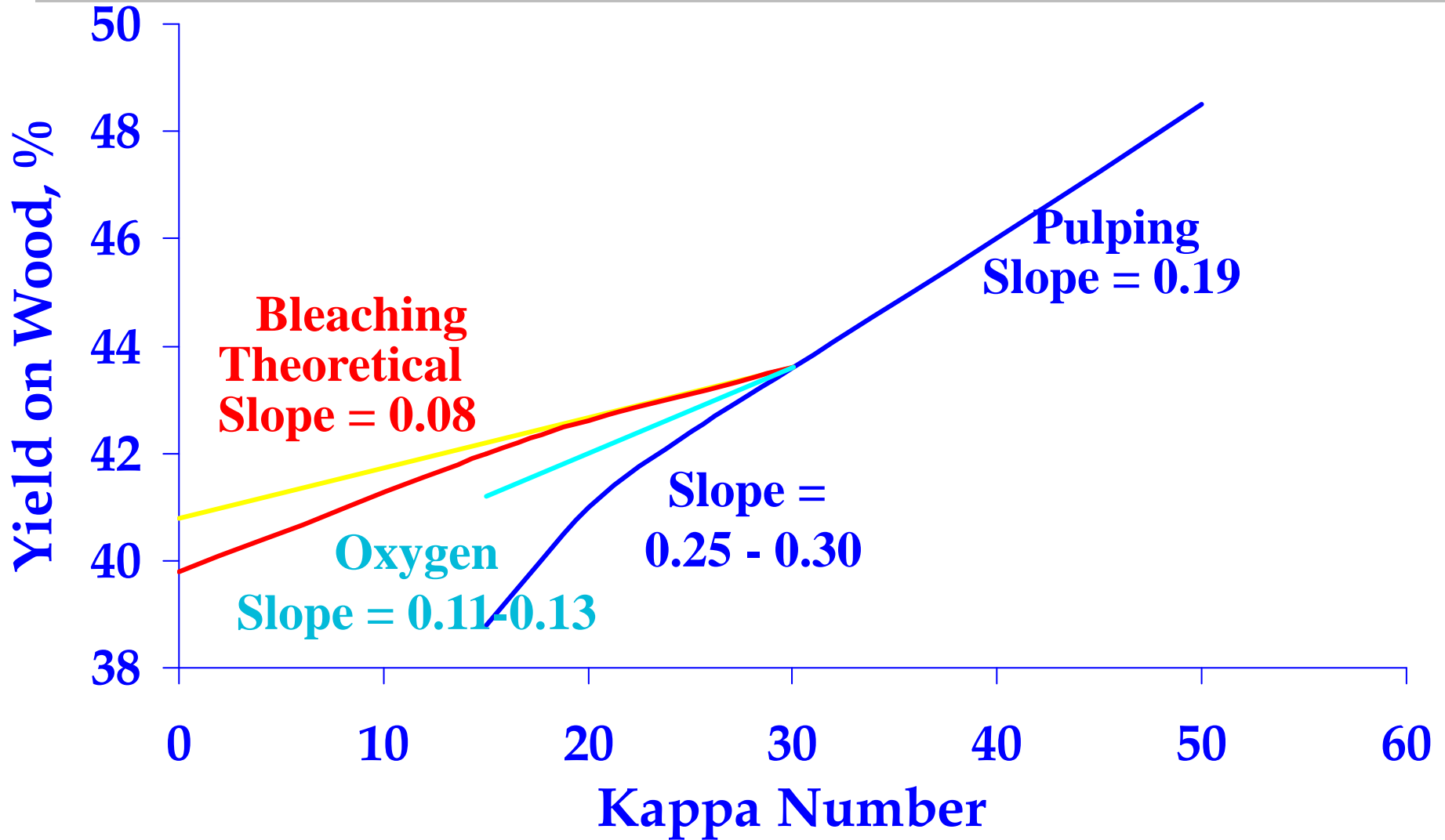



# *Extended Oxygen Delignification*

---

- *Selectivity of oxygen delignification is higher than that for pulping*
- *Why not stop pulping at a higher kappa number and use extended oxygen delignification to decrease the kappa number ?*
  - *Kleppe, Gratzl, Air Products*

# *Yield Kappa Relationships*

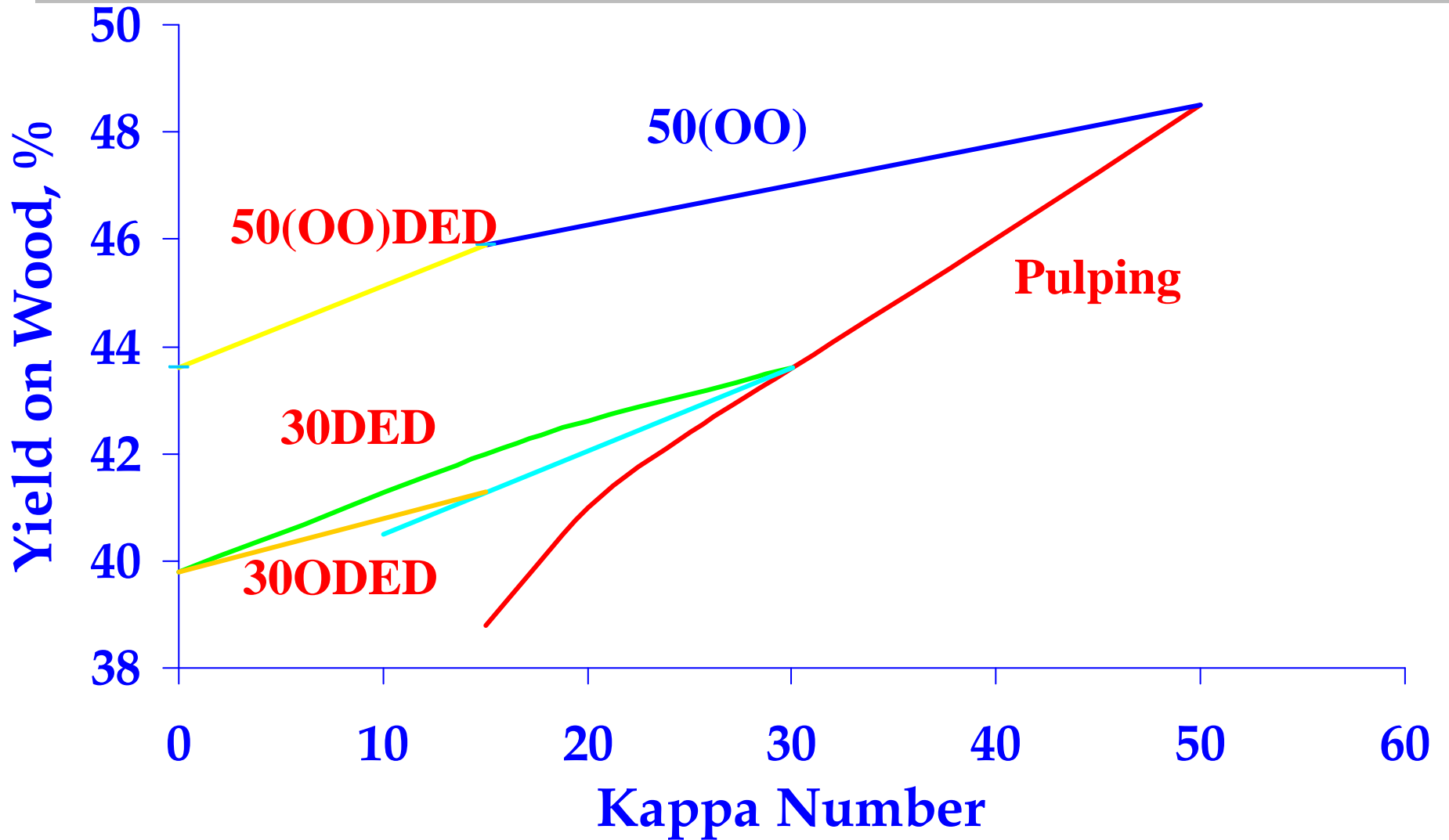

# *Proposed System*

---

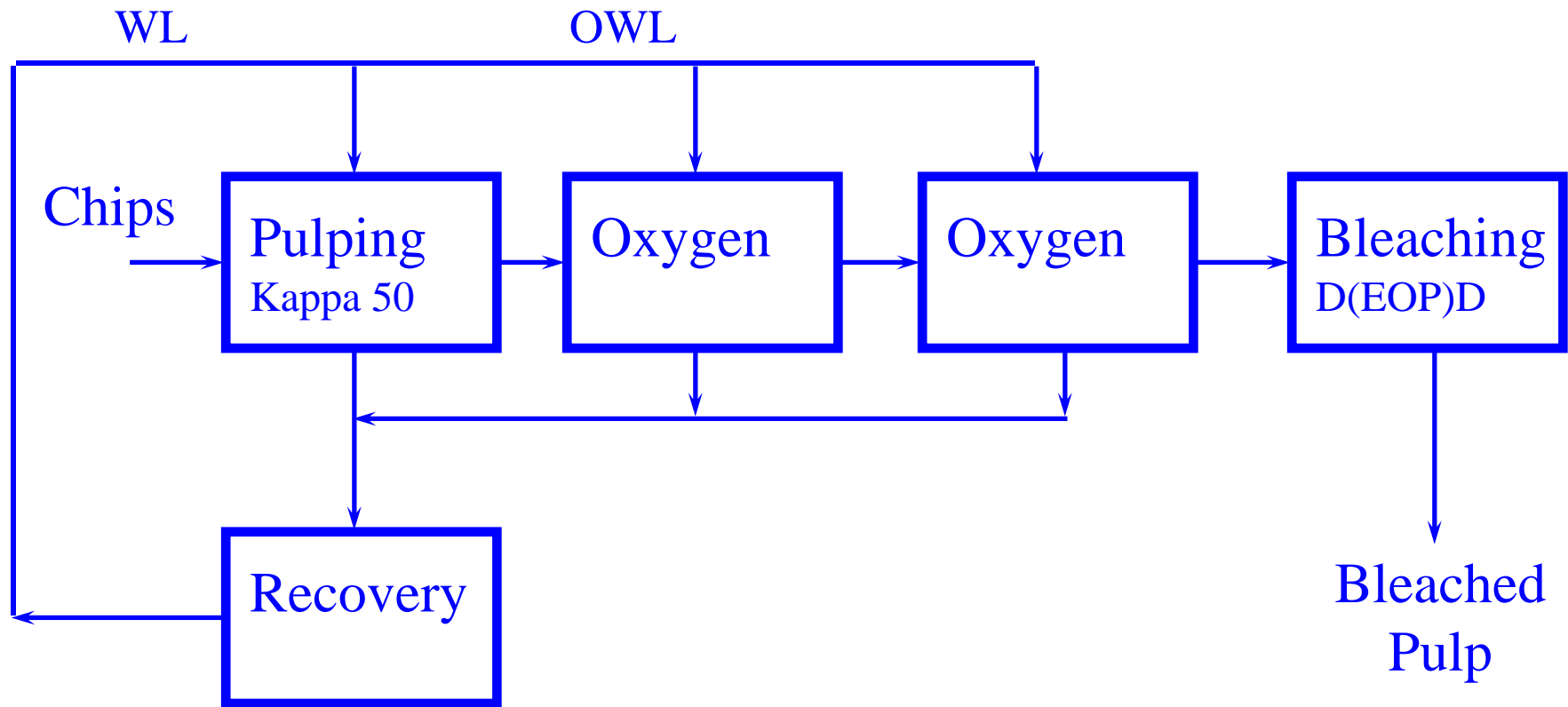

# *Yield Results*

---

	<b>Pulping</b>	<b>Post Oxygen</b>	<b>Bleaching</b>
<b>30ECF</b>	<b>43.3</b>		<b>39.8</b>
<b>30(O)ECF</b>	<b>43.3</b>	<b>41.9</b>	<b>39.9</b>
<b>40(OO)ECF</b>	<b>46.3</b>	<b>43.7</b>	<b>41.8</b>
<b>50(OO)ECF</b>	<b>49.3</b>	<b>45.9</b>	<b>43.6</b>

# *Economics*

---

	<b>Boiler Load MMlb/day</b>	<b>Cost/ODTP \$</b>
<b>30ECF</b>	<b>4.87</b>	<b>197</b>
<b>30(O)ECF</b>	<b>5.04</b>	<b>185</b>
<b>40(OO)ECF</b>	<b>4.67</b>	<b>184</b>
<b>50(OO)ECF</b>	<b>4.19</b>	<b>184</b>

# *Pulping/Oxygen Delignification*

## *50 Kappa*

---

- *High kappa pulping followed by two stage oxygen delignification*
  - *single stage oxygen bleaching*
  - *two stage oxygen bleaching*

# *Single Stage Oxygen Delignification*

---

- *Softwood 50 Kappa pulps prepared*
- *Varying pulping conditions*
  - *Low AA      15%AA*
  - *Medium AA 17%AA*
  - *High AA     19%AA*
- *Temperature kept constant at 170°C*
- *Single stage oxygen delignification studied using experimental design*

# *Pulping Conditions*

## *50 Kappa*

---

	<b>%AA</b>	<b>H- Factor</b>	<b>Kappa</b>	<b>Yield, %</b>	<b>Viscosity cp</b>
<b>Low</b>	<b>15</b>	<b>1650</b>	<b>50</b>	<b>51.0</b>	
<b>Medium</b>	<b>17</b>	<b>1400</b>	<b>50</b>	<b>48.5</b>	<b>34.1</b>
<b>High</b>	<b>19</b>	<b>1060</b>	<b>48</b>	<b>46.4</b>	<b>31.0</b>



# *Oxygen Delignification*

## *50 Kappa 15%AA*

---

NaOH%	Temp	Kappa	Yield	Viscosity	Total Yield
3	70-75	35.5	98	27.5	50.0
1.6	76-77.5	40.3	98.5	29.1	50.2
4.4	76-77.5	34.9	96.8	22.8	49.4
1	90-94	41.0	99	28.0	50.5
3	90-94	30.0	95.7	25.2	48.8
5	90-94	26.0	93.2	18.8	47.5
1.6	100-104	34.0	94.5	22.8	48.2
4.4	104-106	20.0	94	18.0	47.9
3	110-111	24.0	94	17.0	47.9
3	90-94	30.0	95.64	21.1	48.8
3	90-94	30.0	95.5	21.5	48.7

# *Models for Low AA*

## *50 Kappa 15%AA*

---

- *LOW AA PULP:*

- $KAPPA = 30.1123 - 7.06581 * ((NaOH-3)/2) - 6.77534 * ((Temp-90)/20) + 3.70607 * ((NaOH-3)/2)^2$

- $YIELD = 48.90639 - 0.91451 * ((NaOH-3)/2) - 1.1175 * ((Temp-90)/2)$

- $VISCOSITY = 21.84217 - 4.673034 * ((NaOH-3)/2) - 4.67303 * ((Temp-90)/20) + 1.73915 * ((NaOH-3)/2)^2$

# Oxygen Delignification

## 50 Kappa 17%AA

Medium AA Pulping, 50 Kappa						
% NaOH	Temp	Yield	Kappa	Viscosity	Total yield	
3	72	98.0	33.5	27.4	47.5	
1.6	77	99.8	32.7	27.9	48.4	
4.4	77	98.9	30.0	24.2	48.0	
1	91	99.0	38.5	31.4	48.0	
3	90	98.0	28.0	23.9	47.5	
5	91	95.7	24.7	21.3	46.4	
1.6	104	98.0	30.2	26.2	47.5	
4.4	104	94.0	22.5	19.9	45.6	
3	108	95.0	22.7	20.3	46.1	
3	90	98.3	28.7	23.8	47.7	
3	90	98.1	29.0	23.7	47.6	

# *Models for Medium AA*

## *50 Kappa 17%AA*

---

- *MEDIUM AA PULP:*

- $KAPPA = 28.00095 - 5.31616 * ((NaOH-3)/2) - 3.997644 * ((Temp-90)/2) + 3.14666 * ((NaOH-3)/2)^2$

- $YIELD = 47.298 - 0.80028 * ((NaOH-3)/2) - 0.84848 * ((Temp-90)/20) - 0.65933 * ((Temp-90)/2) * ((NaOH-3)/2)$

- $VISCOSITY = 23.6353 - 4.28737 * ((NaOH-3)/2) - 2.55193 * ((Temp-90)/20) + 2.55147 * ((NaOH-3)/2)^2$

# Oxygen Delignification

## 50 Kappa 19%AA

High AA Pulping, 50 Kappa						
NaOH%		Temp	Kappa	Yield	Viscosity	Total Yield
3		70-73	32.3	99.8	19.1	46.3
1.6		76-79	33.1	100.0	21.2	46.4
4.4		76-78	28.3	97.5	17.8	45.2
1		88-89	36.2	99.0	24.6	45.9
3		88-89	27.2	97.7	17.6	45.3
5		90-94	21.8	95.5	15.6	44.3
1.6		100-104	28.4	97.1	22.6	45.1
4.4		102-105	19.7	94.5	12.2	43.8
3		106-109	21.7	96.4	15.1	44.7
3		90-94	25.0	96.7	17.5	44.9
3		88-90	27.0	97.8	17.8	45.4

# *Models for High AA*

## *50 Kappa 19%AA*

---

- *HIGH AA PULP:*

- $KAPPA = 26.46762 - 5.71586 * ((NaOH-3)/2) - 4.97502 * ((Temp-90)/20) - 2.39037 * ((NaOH-3)/2)^2$

- $YIELD = 45.21542 - 0.77563 * ((NaOH-3)/2) - 0.85754 * ((Temp-90)/20)$

- $VISCOSITY = 17.33038 - 4.61892 * ((NaOH-3)/2) - 1.73502 * ((Temp-90)/20) - 2.65152 * ((NaOH-3)/2)^2$

# *Influence Of Pulping Conditions*

---

- *Kappa Reduction*
- *Yield Selectivity*
- *Viscosity Selectivity*

# *Kappa Reduction*

*1% NaOH*

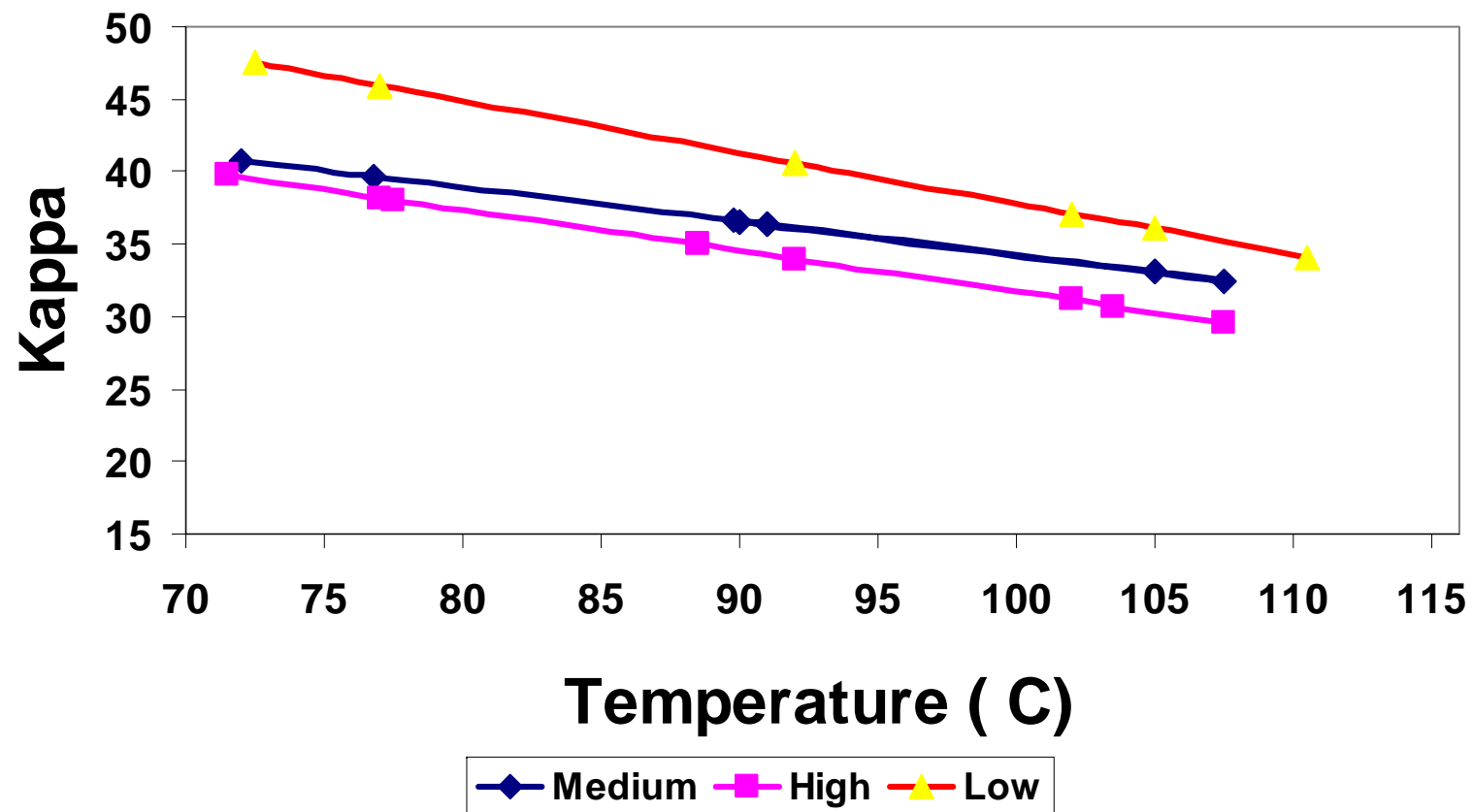



# *Kappa Reduction*

*3% NaOH*

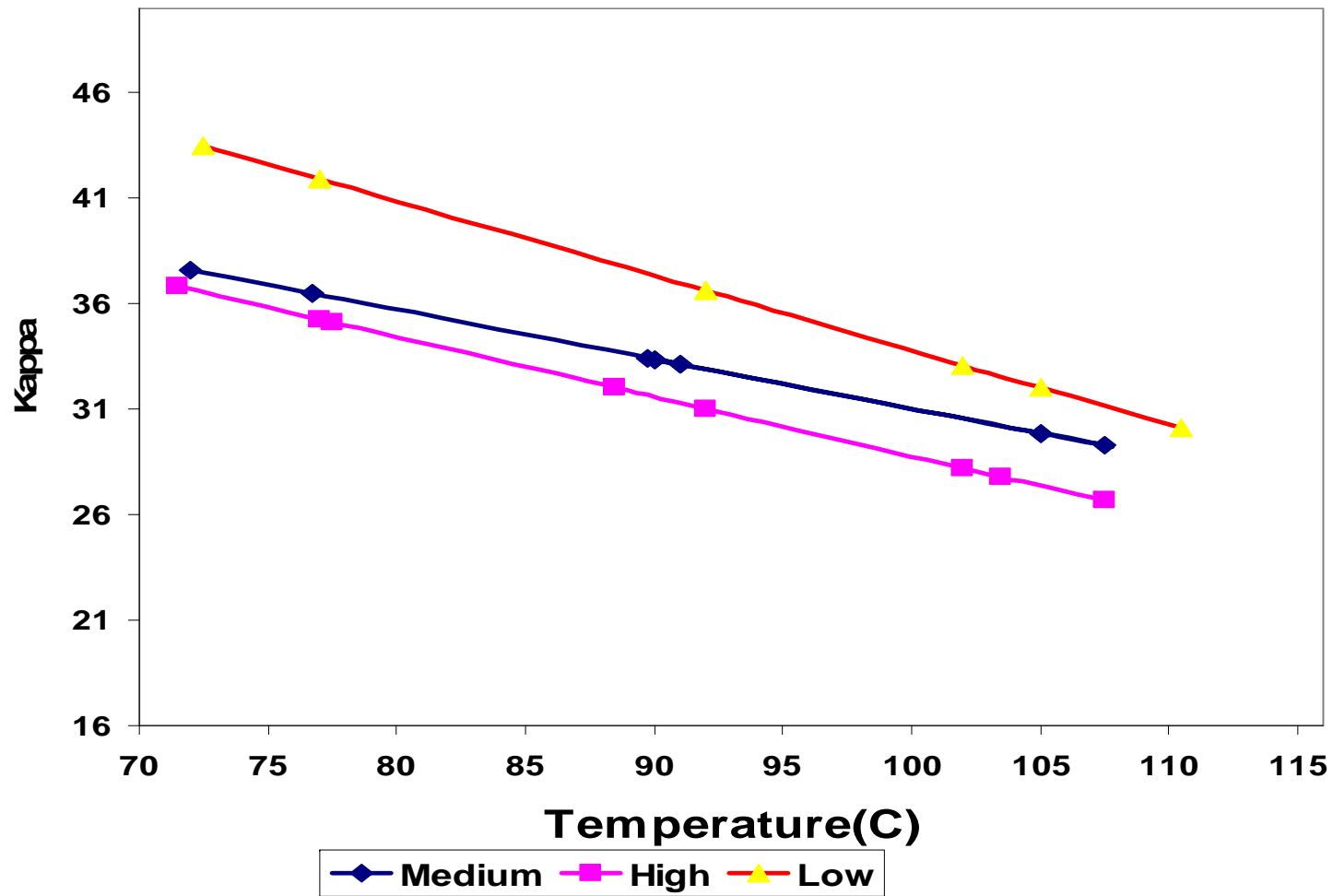

# *Kappa Reduction*

## *100°C*

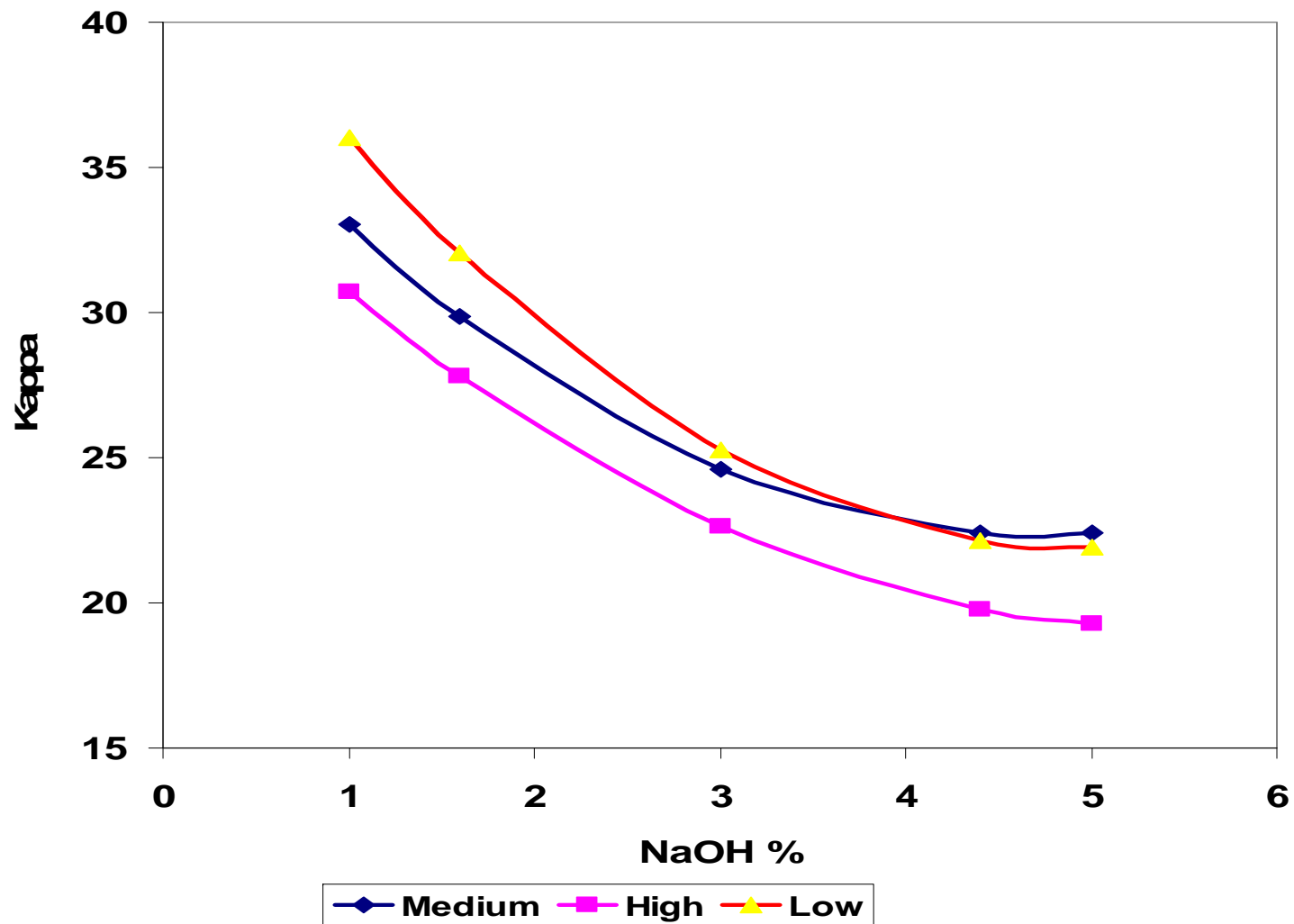

# *Yield Selectivity*

*3% NaOH*

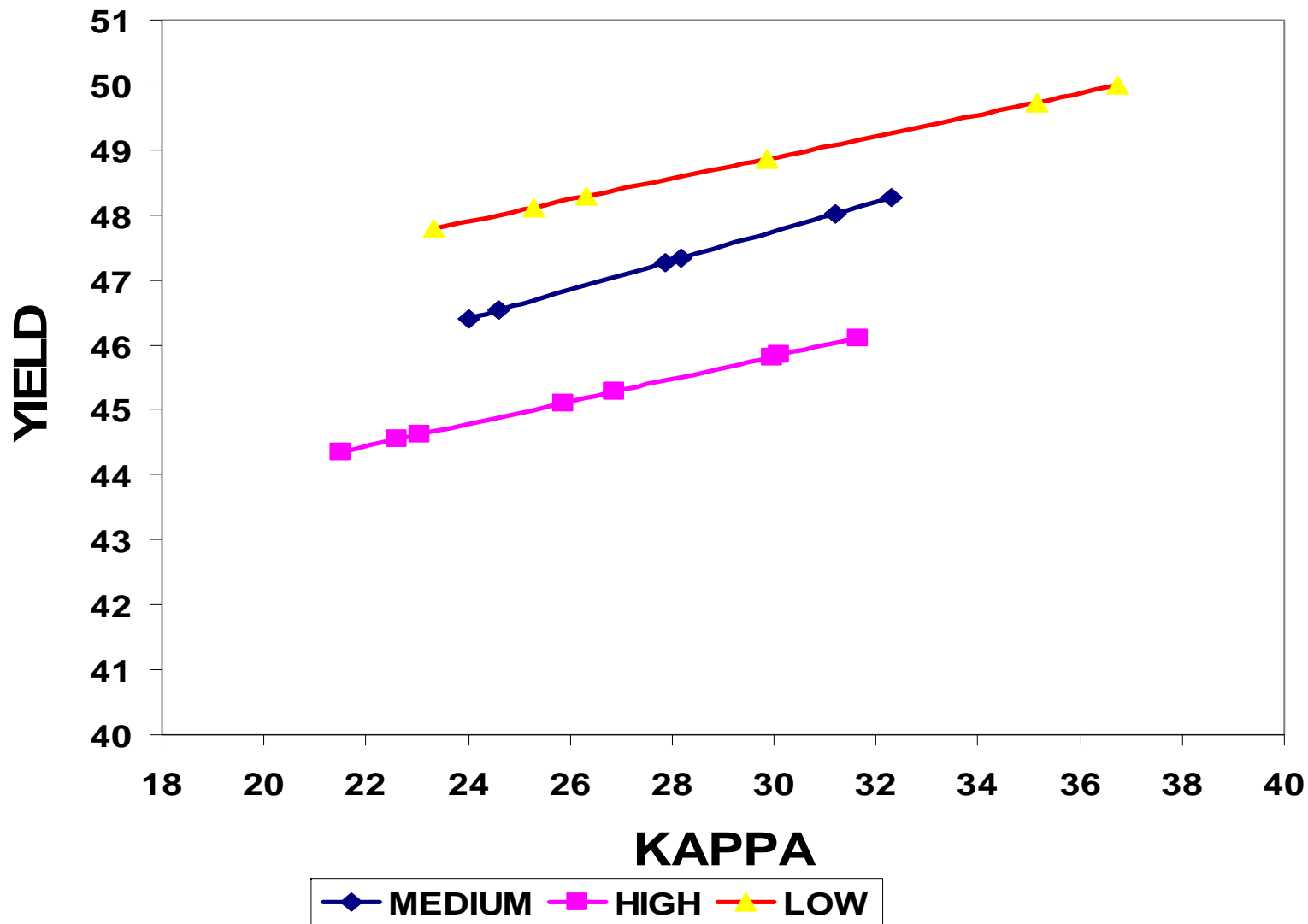

# Viscosity Selectivity

3% NaOH

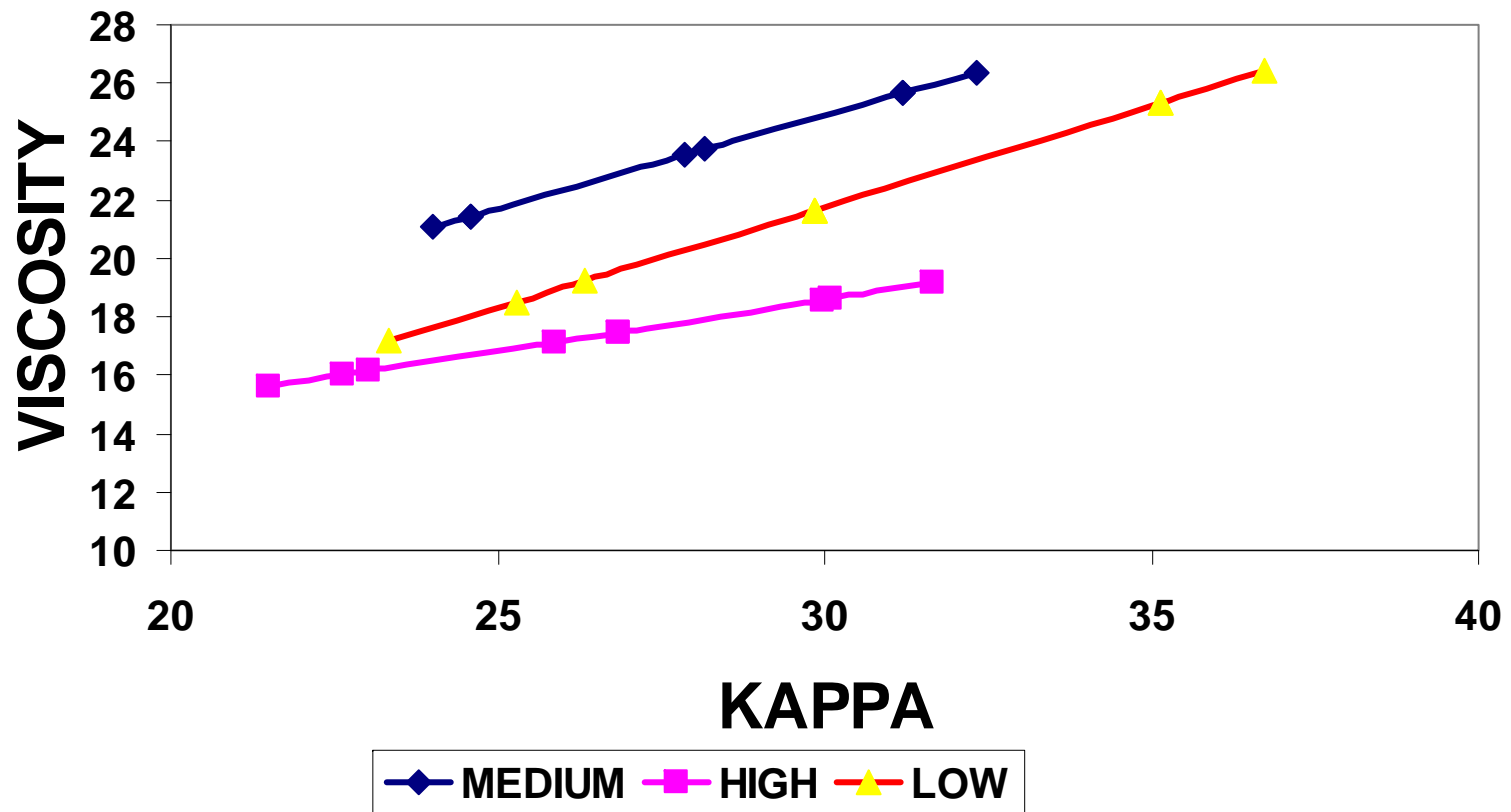

# *Yield Kappa Relationships*

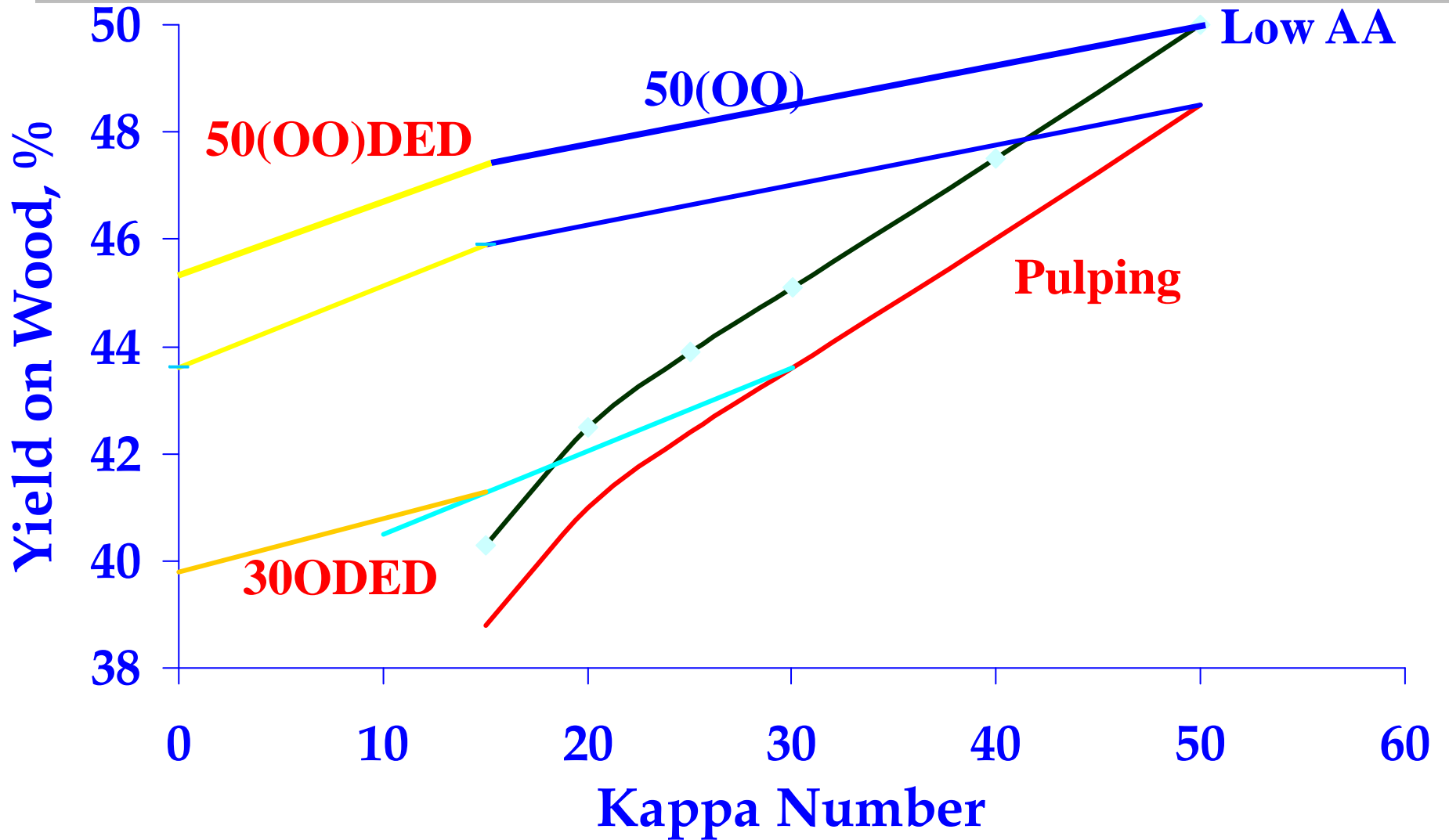

# *Validation of Results*

## *50 Kappa*

---

	17% AA	21% AA
Pulping		
%AA	15	19
H Factor	1650	1050
Kappa	49	48
Yield, %	49.5	47.5
Viscosity, cp	37 ??	40

# *Validation of Results*

## *50 Kappa*

---

	<b>17% AA</b>	<b>21% AA</b>
<b>Oxygen Stage 1</b>		
<b>%NaOH</b>	<b>3</b>	<b>3</b>
<b>Temp, C</b>	<b>92</b>	<b>81</b>
<b>Kappa</b>	<b>30</b>	<b>30</b>
<b>Oxygen yield, %</b>	<b>97.5</b>	<b>97.9</b>
<b>Total yield,% (Pulp+O2)</b>	<b>48.3</b>	<b>46.5</b>
<b>Viscosity, cp</b>	<b>34.7</b>	<b>30.5</b>

# *Validation of Results*

## *50 Kappa*

---

	<b>17% AA</b>	<b>21% AA</b>
<b>Oxygen Stage 2</b>		
<b>%NaOH</b>	<b>3</b>	<b>3</b>
<b>Temp, C</b>	<b>110</b>	<b>110</b>
<b>Kappa</b>	<b>15.5</b>	<b>15</b>
<b>Oxygen yield, %</b>	<b>96.1</b>	<b>96.8</b>
<b>Total yield,% (Pulp+O2)</b>	<b>46.4</b>	<b>44.3</b>
<b>Viscosity, cp</b>	<b>22.3</b>	<b>21.8</b>



# *Comparison to 30 Kappa Pulping*

---

	<b>17% AA</b>	<b>21% AA</b>
<b>Pulping Kappa</b>	<b>30</b>	<b>30</b>
<b>Pulping Yield, %</b>	<b>46.5</b>	<b>43.5</b>
<b>Oxygen Stage</b>		
<b>Kappa</b>	<b>16</b>	<b>16.5</b>
<b>Oxygen yield, %</b>	<b>97</b>	<b>96.8</b>
<b>Total yield,% (Pulp+O2)</b>	<b>45.1</b>	<b>42.1</b>
<b>Viscosity, cp</b>	<b>24.5</b>	<b>21</b>

# *High Kappa Pulping of HW*

---

- *Pulp HW to higher kappa number and use two stage oxygen delignification*
  - *Optimum kappa number*

# Summary

---

- *At 50 kappa the oxygen stage performance similar to before*
  - *The higher alkali charge in pulping resulted in lower yield at the same kappa number*
  - *15%AA            51% yield*
  - *19%AA            46.4% yield*
  - *The pulps produced with the low AA were slightly more difficult to delignify as compared to the high AA pulps*
  - *The yield and viscosity selectivity was higher for the low %AA in pulping*
    - *improvements of up to 3% in yield*
    - *improvements of up to 6cp in viscosity*

# Summary

---

- *High kappa pulping in combination with extended oxygen delignification can be used to increase overall pulp yield*
- *The kappa number from pulping should be decided based on*
  - *pulp properties*
  - *economics*
  - *environmental*
  - *mill constraints (boiler, causticization)*

# *Conclusions*

---

- *The results show there is tremendous potential for improving the yield, pulp properties and oxygen bleaching performance by:*
  - *optimizing the pulping and oxygen bleaching together*